

R-XPT Throughbolt

Throughbolt for non-cracked concrete



Approvals and Reports

- ETA 17/0183
- UKTA-22/6201



Product information

Features and benefits

- High performance in non-cracked concrete confirmed by ETA Option 7
- High quality with cost effectiveness
- Suitable for reduced embedment to avoid contact with reinforcement
- Embedment depth markings help to ensure precise installation of the anchor
- Design allows drilling and installing directly through the fixture and helps to reduce installation effort
- Cold formed body ensures consistent dimensional accuracy
- Simple through-installation (drilling and installation through fixed material)
- Optimized expander design with six grip features allows for a high load-bearing capacity

Applications

- Cladding restraint
- Curtain wall
- Balustrading
- Barriers
- Handrails
- Racking
- Structural steel
- Bollards

Base materials

Approved for use in:

- Non-cracked concrete C20/25-C50/60
- Unreinforced concrete
- Reinforced concrete

Also suitable for use in:

- Natural Stone (after site testing)

Installation guide

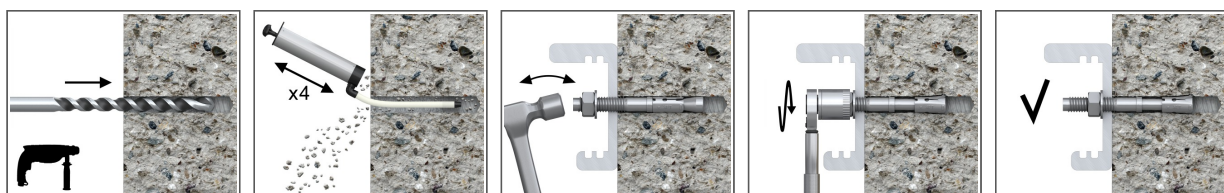

1. Drill a hole of required diameter and depth
2. Clear the hole of drilling dust and debris (using blowpump or equivalent method)
3. Lightly tap the throughbolt through the fixture into hole with a hammer, until fixing depth is reached
4. Tighten to the recommended torque

Product information

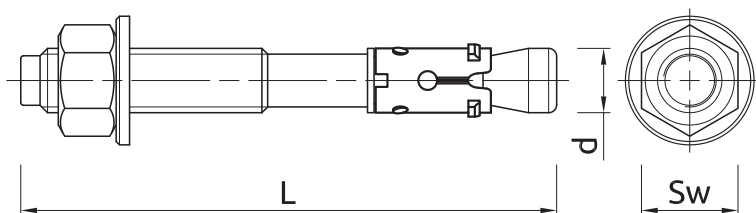

Size	Product Code	Approval type	Anchor		Fixture			
			Diameter	Length	Max. thickness t_{fix} for:		Hole diameter	
			d	L	$h_{nom,red}$	$h_{nom,std}$	d_f	
		-	[mm]	[mm]	[mm]	[mm]	[mm]	[mm]
M6	R-XPT-06050/10	AT-15-9327/14	6	50	10	-	7	
	R-XPT-06065/5	AT-15-9327/14	6	65	25	5	7	
	R-XPT-06085/25	AT-15-9327/14	6	85	45	25	7	
	R-XPT-06100/40	AT-15-9327/14	6	100	60	40	7	
M8	R-XPT-08050/5	AT-15-9327/14	8	50	5	-	9	
	R-XPT-08060/10	ETA 17/0183	8	60	10	-	9	
	R-XPT-08065/15	ETA 17/0183	8	65	15	-	9	
	R-XPT-08075/10	ETA 17/0183	8	75	25	10	9	
	R-XPT-08080/15	ETA 17/0183	8	80	30	15	9	
	R-XPT-08085/20	ETA 17/0183	8	85	35	20	9	
	R-XPT-08095/30	ETA 17/0183	8	95	45	30	9	
	R-XPT-08115/50	ETA 17/0183	8	115	65	50	9	
	R-XPT-08140/75	ETA 17/0183	8	140	90	75	9	
	R-XPT-08150/85	ETA 17/0183	8	150	100	85	9	
M10	R-XPT-10065/5	ETA 17/0183	10	65	5	-	12	
	R-XPT-10080/10	ETA 17/0183	10	80	20	10	12	
	R-XPT-10095/25	ETA 17/0183	10	95	35	25	12	
	R-XPT-10115/45	ETA 17/0183	10	115	55	45	12	
	R-XPT-10130/60	ETA 17/0183	10	130	70	60	12	
	R-XPT-10140/70	ETA 17/0183	10	140	80	70	12	
	R-XPT-10150/80	ETA 17/0183	10	150	90	80	12	
	R-XPT-10180/110	ETA 17/0183	10	180	120	110	12	
M12	R-XPT-12080/5	ETA 17/0183	12	80	5	-	14	
	R-XPT-12100/5	ETA 17/0183	12	100	25	5	14	
	R-XPT-12120/25	ETA 17/0183	12	120	45	25	14	
	R-XPT-12125/30	ETA 17/0183	12	125	50	30	14	
	R-XPT-12135/40	ETA 17/0183	12	135	60	40	14	
	R-XPT-12140/45	ETA 17/0183	12	140	65	45	14	
	R-XPT-12150/55	ETA 17/0183	12	150	75	55	14	
	R-XPT-12160/65	ETA 17/0183	12	160	85	65	14	
	R-XPT-12180/85	ETA 17/0183	12	180	105	85	14	
	R-XPT-12200/105	ETA 17/0183	12	200	125	105	14	
	R-XPT-12220/125	ETA 17/0183	12	220	145	125	14	
	R-XPT-12250/155	ETA 17/0183	12	250	175	155	14	
R-XPT-12280/185	ETA 17/0183	12	280	205	185	14		
M16	R-XPT-16090/10	-	16	90	0	0	18	
	R-XPT-16100/5	ETA 17/0183	16	100	5	-	18	
	R-XPT-16105/10	ETA 17/0183	16	105	10	-	18	
	R-XPT-16125/5	ETA 17/0183	16	125	25	5	18	
	R-XPT-16140/20	ETA 17/0183	16	140	40	20	18	
	R-XPT-16150/30	ETA 17/0183	16	150	50	30	18	
	R-XPT-16160/40	ETA 17/0183	16	160	60	40	18	
	R-XPT-16180/60	ETA 17/0183	16	180	80	60	18	
R-XPT-16200/80	ETA 17/0183	16	200	100	80	18		

Product information

Size	Product Code	Approval type	Anchor		Fixture		
			Diameter	Length	Max. thickness t_{fix} for:		Hole diameter
			d	L	$h_{nom,red}$	$h_{nom,std}$	d_f
			[mm]	[mm]	[mm]	[mm]	[mm]
M16	R-XPT-16220/100	ETA 17/0183	16	220	120	100	18
	R-XPT-16250/130	ETA 17/0183	16	250	150	130	18
	R-XPT-16280/160	ETA 17/0183	16	280	180	160	18
	R-XPT-16300/180	ETA 17/0183	16	300	200	180	18
M20	R-XPT-20125/5	ETA 17/0183	20	125	5	-	22
	R-XPT-20160/20	ETA 17/0183	20	160	40	20	22
	R-XPT-20200/60	ETA 17/0183	20	200	80	60	22
	R-XPT-20250/110	ETA 17/0183	20	250	130	110	22
	R-XPT-20300/160	ETA 17/0183	20	300	180	160	22
M24	R-XPT-24180/20	AT-15-9327/14	24	180	35	20	26
	R-XPT-24260/100	AT-15-9327/14	24	260	115	100	26
	R-XPT-24300/140	AT-15-9327/14	24	300	155	140	26

Installation data

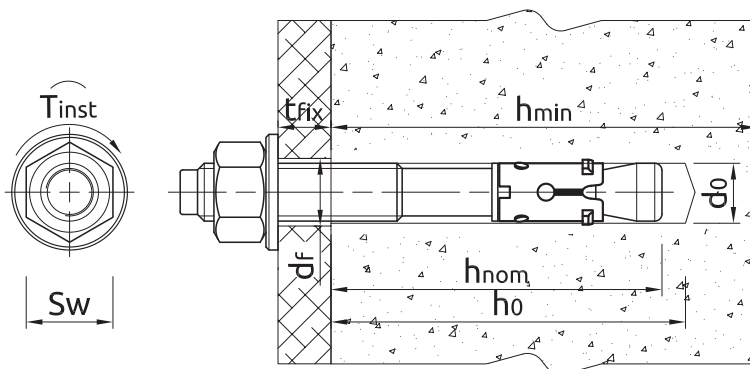

Size			M6	M8	M10	M12	M16	M20	M24
Thread diameter	d	[mm]	6	8	10	12	16	20	24
Hole diameter in substrate	d_0	[mm]	6	8	10	12	16	20	24
Installation torque	T_{inst}	[Nm]	5	15	30	50	100	200	300
Wrench size	Sw	[mm]	10	13	17	19	24	30	36
External diameter of washer		[mm]	12	16	20	24	30	37	44
STANDARD EMBEDMENT DEPTH									
Min. hole depth in substrate	$h_{0,s}$	[mm]	55	65	69	90	110	129	140
Min. installation depth	$h_{nom,s}$	[mm]	50	55	59	80	100	119	135
Min. substrate thickness	$h_{min,s}$	[mm]	84	100	100	136	170	198	224
Min. spacing	$s_{min,s}$	[mm]	45	50	55	75	90	140	180
Min. edge distance	$c_{min,s}$	[mm]	50	40	50	65	80	100	200
REDUCED EMBEDMENT DEPTH									
Min. hole depth in substrate	$h_{0,r}$	[mm]	35	50	59	70	90	110	125
Min. installation depth	$h_{nom,r}$	[mm]	30	40	49	60	80	100	120
Min. substrate thickness	$h_{min,r}$	[mm]	80	100	100	100	130	158	194
Min. spacing	$s_{min,r}$	[mm]	40	45	55	100	100	125	160
Min. edge distance	$c_{min,r}$	[mm]	45	40	65	100	100	125	160

Mechanical properties

Size			M6	M8	M10	M12	M16	M20	M24
Nominal ultimate tensile strength - tension	f_{uk}	[N/mm ²]	600	600	600	600	600	600	600
Nominal yield strength - tension	f_{yk}	[N/mm ²]	480	480	480	480	480	480	480
Cross sectional area - tension	A_s	[mm ²]	21.1	36.6	58	84.3	157	245	350
Elastic section modulus	W_{el}	[mm ³]	21.21	31.24	62.32	109.2	277.54	544.4	935
Characteristic bending resistance	$M^0_{Rk,s}$	[Nm]	7	22	45	79	200	392	525
Design bending resistance	M	[Nm]	5.6	17.6	36	63.2	160	313.6	420

Basic performance data

Performance data for single anchor without influence of edge distance and spacing

Size		M6	M8	M10	M12	M16	M20	M24
MEAN ULTIMATE LOAD								
TENSION LOAD $N_{Ru,m}$								
Standard embedment depth	[kN]	8.70	18.10	19.80	28.00	49.70	65.30	67.60
Reduced embedment depth	[kN]	5.70	10.90	11.40	21.50	37.00	45.50	62.70
SHEAR LOAD $V_{Ru,m}$								
Standard embedment depth	[kN]	6.00	12.20	19.20	28.00	51.50	80.90	118.60
Reduced embedment depth	[kN]	6.00	12.20	16.44	22.45	51.50	74.14	115.20
CHARACTERISTIC LOAD								
TENSION LOAD N_{Rk}								
Standard embedment depth	[kN]	8.67	12.00	15.00	24.00	38.55	44.00	38.14
Reduced embedment depth	[kN]	4.27	8.90	9.00	16.00	25.78	34.54	31.92
SHEAR LOAD V_{Rk}								
Standard embedment depth	[kN]	5.50	11.00	16.87	25.30	47.10	73.50	97.10
Reduced embedment depth	[kN]	5.50	8.90	11.98	16.36	47.10	69.08	93.99
DESIGN LOAD								
TENSION LOAD N_{Rd}								
Standard embedment depth	[kN]	3.44	8.00	10.00	16.00	25.70	29.33	15.13
Reduced embedment depth	[kN]	1.69	5.94	6.00	10.67	17.19	23.03	12.67
SHEAR LOAD V_{Rd}								
Standard embedment depth	[kN]	4.40	8.80	11.25	20.24	37.68	58.80	77.68
Reduced embedment depth	[kN]	3.38	5.94	7.99	10.91	34.37	46.06	62.66

Design performance data

(-) Failure is not decisive

Size			M6		M8		M10		M12		M16		M20		M24	
Effective embedment depth	h_{ef}	[mm]	22.00	42.00	32.00	47.00	39.00	49.00	48.00	68.00	65.00	85.00	79.00	99.00	97.00	112.0
TENSION LOAD																
STEEL FAILURE																
Characteristic resistance	$N_{Rk,s}$	[kN]	8.84	8.84	17.50	17.50	27.60	27.60	40.00	40.00	71.00	71.00	108.4	108.4	145.4	145.4
Partial safety factor	γ_{Ms}	-	1.40	1.40	1.50	1.50	1.50	1.50	1.50	1.50	1.50	1.50	1.50	1.50	1.40	1.40
PULL-OUT FAILURE; NON-CRACKED CONCRETE C20/25																
Characteristic resistance	$N_{Rk,p}$	[kN]	4.27	8.67	9.00	12.00	9.00	15.00	16.00	24.00	28.00	40.00	36.00	44.00	31.92	38.14
PULL-OUT FAILURE																
Installation safety factor	γ_{inst}	-	1.68	1.68	1.00	1.00	1.00	1.00	1.00	1.00	1.00	1.00	1.00	1.00	1.68	1.68
Increasing factors for $N_{Rd,p}$ - C30/37	ψ_c	-	1.00	1.00	1.23	1.16	1.23	1.23	1.21	1.23	1.23	1.23	1.23	1.23	1.00	1.00
Increasing factors for $N_{Rd,p}$ - C40/50	ψ_c	-	1.00	1.00	1.43	1.28	1.43	1.43	1.39	1.43	1.43	1.43	1.43	1.43	1.00	1.00
Increasing factors for $N_{Rd,p}$ - C50/60	ψ_c	-	1.00	1.00	1.58	1.40	1.58	1.58	1.52	1.58	1.58	1.58	1.58	1.58	1.00	1.00
CONCRETE CONE FAILURE																
Factor for non-cracked concrete	$k_{ucr,N}$	-	11.00	11.00	11.00	11.00	11.00	11.00	11.00	11.00	11.00	11.00	11.00	11.00	11.00	11.00
Installation safety factor	γ_{inst}	-	1.68	1.68	1.00	1.00	1.00	1.00	1.00	1.00	1.00	1.00	1.00	1.00	1.68	1.68
Spacing	$s_{cr,N}$	[mm]	66.00	126.0	96.00	141.0	117.0	147.0	144.0	204.0	195.0	255.0	237.0	297.0	291.0	336.0
Edge distance	$c_{cr,N}$	[mm]	33.00	63.00	48.00	71.00	59.00	74.00	72.00	102.0	98.00	128.0	119.0	149.0	156.0	168.0
CONCRETE SPLITTING FAILURE																
Spacing	$s_{cr,sp}$	[mm]	110.0	210.0	160.0	240.0	200.0	260.0	250.0	370.0	360.0	430.0	410.0	530.0	500.0	580.0
Edge distance	$c_{cr,sp}$	[mm]	55.00	105.0	80.00	120.0	100.0	130.0	125.0	185.0	180.0	215.0	205.0	265.0	250.0	290.0
Installation safety factor	γ_{inst}	-	1.68	1.68	1.00	1.00	1.00	1.00	1.00	1.00	1.00	1.00	1.00	1.00	1.68	1.68
SHEAR LOAD																
STEEL FAILURE																
Characteristic resistance without lever arm	$V_{Rk,s}$	[kN]	5.50	5.50	11.00	11.00	17.40	17.40	25.30	25.30	47.10	47.10	73.50	73.50	97.10	97.10
Ductility factor	k_γ	-	1.00	0.80	1.00	1.00	1.00	1.00	1.00	1.00	1.00	1.00	1.00	1.00	1.00	0.80
Characteristic resistance with lever arm	$M_{Rk,s}$	[Nm]	7.34	7.34	22.00	22.00	45.00	45.00	79.00	79.00	200.0	200.0	392.0	392.0	525.0	525.0
Partial safety factor	γ_{Ms}	-	1.25	1.25	1.25	1.25	1.25	1.25	1.25	1.25	1.25	1.25	1.25	1.25	1.25	1.25
CONCRETE PRY-OUT FAILURE																
Factor	k	-	1.00	1.00	1.00	1.00	1.00	1.00	1.00	2.00	2.00	2.00	2.00	2.00	2.00	2.00
Installation safety factor	γ_{inst}	-	1.00	1.00	1.00	1.00	1.00	1.00	1.00	1.00	1.00	1.00	1.00	1.00	1.00	1.00
CONCRETE EDGE FAILURE																
Effective length of anchor	ℓ_f	[mm]	22.00	42.00	32.00	47.00	39.00	49.00	48.00	68.00	65.00	85.00	79.00	99.00	97.00	112.0
Anchor diameter	d_{nom}	[mm]	6.00	6.00	8.00	8.00	10.00	10.00	12.00	12.00	16.00	16.00	20.00	20.00	24.00	24.00
Installation safety factor	γ_{inst}	-	1.00	1.00	1.00	1.00	1.00	1.00	1.00	1.00	1.00	1.00	1.00	1.00	1.00	1.00

The use of the reduced embedment depth M8 and M10 is restricted to anchoring statically indeterminate structural components.

Product commercial data

Product Code	Anchor		Quantity [pcs]			Weight [kg]			Bar Codes
	Diameter [mm]	Length [mm]	Box	Outer	Pallet	Box	Outer	Pallet	
R-XPT-06050/10	6	50	100	100	16000	1.27	1.27	233.2	5906675233499
R-XPT-06065/5	6	65	100	100	16000	1.55	1.55	278.0	5906675233505
R-XPT-06085/25	6	85	100	100	16000	1.85	1.85	326.0	5906675233512
R-XPT-06100/40	6	100	100	100	16000	2.1	2.1	370.8	5906675250311
R-XPT-08050/5 ¹⁾	8	50	100	100	16000	2.3	2.3	396.4	5906675250328
R-XPT-08060/10 ¹⁾	8	60	100	100	16000	2.6	2.6	446.0	5906675234601
R-XPT-08065/15 ¹⁾	8	65	100	100	16000	2.7	2.7	465.2	5906675250335
R-XPT-08075/10 ¹⁾	8	75	100	100	16000	3.1	3.1	518.0	5906675233536
R-XPT-08080/15 ¹⁾	8	80	100	100	16000	3.2	3.2	542.0	5906675250342
R-XPT-08085/20 ¹⁾	8	85	100	100	16000	3.4	3.4	578.8	5906675249636
R-XPT-08095/30 ¹⁾	8	95	100	100	12000	3.7	3.7	469.2	5906675233543
R-XPT-08115/50 ¹⁾	8	115	100	100	12000	4.3	4.3	540.0	5906675233550

Product commercial data

Product Code	Anchor		Quantity [pcs]			Weight [kg]			Bar Codes
	Diameter [mm]	Length [mm]	Box	Outer	Pallet	Box	Outer	Pallet	
R-XPT-08140/75 ¹⁾	8	140	100	100	16000	5.2	5.2	855.6	5906675233567
R-XPT-08150/85 ¹⁾	8	150	100	100	16000	5.4	5.4	887.6	5906675250359
R-XPT-10065/5 ¹⁾	10	65	50	50	8000	2.4	2.4	408.4	5906675233574
R-XPT-10080/10 ¹⁾	10	80	50	50	8000	2.7	2.7	468.4	5906675233581
R-XPT-10095/25 ¹⁾	10	95	50	50	8000	3.1	3.1	527.6	5906675233598
R-XPT-10115/45 ¹⁾	10	115	50	50	6000	3.6	3.6	463.2	5906675233604
R-XPT-10130/60 ¹⁾	10	130	50	50	8000	4.0	4.0	664.4	5906675249643
R-XPT-10140/70 ¹⁾	10	140	50	50	8000	4.2	4.2	705.2	5906675233611
R-XPT-10150/80 ¹⁾	10	150	50	50	8000	4.5	4.5	742.0	5906675249650
R-XPT-10180/110 ¹⁾	10	180	50	50	6000	5.2	5.2	654.6	5906675250366
R-XPT-12080/5 ¹⁾	12	80	50	50	8000	4.1	4.1	678.0	5906675233628
R-XPT-12100/5 ¹⁾	12	100	50	50	8000	4.8	4.8	792.4	5906675233635
R-XPT-12120/25 ¹⁾	12	120	50	50	6000	5.5	5.5	690.0	5906675250373
R-XPT-12125/30 ¹⁾	12	125	50	50	6000	5.7	5.7	709.2	5906675233642
R-XPT-12135/40 ¹⁾	12	135	50	50	6000	6.1	6.1	757.8	5906675250380
R-XPT-12140/45 ¹⁾	12	140	50	50	6000	6.2	6.2	769.2	5906675249667
R-XPT-12150/55 ¹⁾	12	150	50	50	4000	6.6	6.6	558.4	5906675233659
R-XPT-12160/65 ¹⁾	12	160	50	50	4000	6.9	6.9	584.4	5906675216416
R-XPT-12180/85 ¹⁾	12	180	50	50	4000	7.6	7.6	639.2	5906675233666
R-XPT-12200/105 ¹⁾	12	200	50	50	4000	8.3	8.3	696.4	5906675312132
R-XPT-12220/125 ¹⁾	12	220	50	50	4000	9.1	9.1	755.2	5906675233673
R-XPT-12250/155 ¹⁾	12	250	25	25	3000	5.1	5.1	637.8	5906675312149
R-XPT-12280/185 ¹⁾	12	280	20	20	1600	4.6	4.6	395.8	5906675312156
R-XPT-16090/10 ¹⁾	16	90	25	25	4000	4.1	4.1	679.6	5906675250397
R-XPT-16100/5 ¹⁾	16	100	25	25	4000	4.4	4.4	731.6	5906675233680
R-XPT-16105/10 ¹⁾	16	105	25	25	4000	4.6	4.6	763.6	5906675250403
R-XPT-16125/5 ¹⁾	16	125	25	25	4000	5.3	5.3	869.6	5906675233697
R-XPT-16140/20 ¹⁾	16	140	25	25	4000	5.7	5.7	948.4	5906675249063
R-XPT-16150/30 ¹⁾	16	150	25	25	4000	6.1	6.1	1001.2	5906675249674
R-XPT-16160/40 ¹⁾	16	160	25	25	3000	6.4	6.4	792.9	5906675250410
R-XPT-16180/60 ¹⁾	16	180	25	25	3000	7.0	7.0	873.3	5906675249681
R-XPT-16200/80 ¹⁾	16	200	25	25	3000	7.6	7.6	946.8	5906675312163
R-XPT-16220/100 ¹⁾	16	220	25	25	3000	8.4	8.4	1037.4	5906675233727
R-XPT-16250/130 ¹⁾	16	250	25	25	2000	9.3	9.3	775.4	5906675312170
R-XPT-16280/160 ¹⁾	16	280	15	15	1200	6.3	6.3	532.3	5906675250427
R-XPT-16300/180 ¹⁾	16	300	10	10	1560	4.4	4.4	722.5	5906675312187
R-XPT-20125/5 ¹⁾	20	125	25	25	3000	8.3	8.3	1020.0	5906675233734
R-XPT-20160/20 ¹⁾	20	160	25	25	2000	10.1	10.1	836.0	5906675233741
R-XPT-20200/60 ¹⁾	20	200	10	10	1200	4.9	4.9	619.7	5906675233758
R-XPT-20250/110 ¹⁾	20	250	10	10	1200	6.0	6.0	748.2	5906675312194
R-XPT-20300/160 ¹⁾	20	300	10	10	800	7.1	7.1	593.7	5906675233765
R-XPT-24180/20	24	180	10	10	1200	7.0	7.0	872.2	5906675233772
R-XPT-24260/100	24	260	10	10	1200	9.3	9.3	1148.8	5906675233789
R-XPT-24300/140	24	300	10	10	800	10.5	10.5	872.7	5906675233796

1) ETA 17/0183